

WIND POWERED VENTILATION



About Alu Roofing



- **Alu Roofing company was established in 2015 and offers technical support and advice in the field of ventilation for roof structures, attic spaces, ventilation shafts of residential buildings and industrial and agricultural buildings. The Founder of the company worked in the building industry and especially roof ventilation as a Technical and Sales adviser for the HPI company (House Profi International – Kloeber - BMI Group) since 2013.**
- **At the same time, the company managed to gain exclusivity for the sale of Lomanco ventilation products in the UK and also Darco chimney cowl. Specialising in the ventilation of roofs, interiors, ventilation shafts and chimneys.**

About Alu Roofing



- In 2016, Alu Roofing succeeded in establishing a partnership with the UK's largest online construction business Roofing Superstore - Constructions Materials Online.
- In 2018/9, the company began to co-operate with Travis Perkins and Roof Giant.
- In 2019, Alu Roofing managed to establish co-operation with the Finnish company Vilpe® and gained exclusivity to also sell their ventilation cowls and chimneys in the UK.
- We have also produced new EN certification (EU harmonized standards) for Lomanco turbines in 2019

Lomanco Whirlybird Certification

The Lomanco Whirlybird has been tested and verified by the Engineering and test institute, Public Enterprise. The link to the EU Harmonised certification is here

<https://www.aluroofing.co.uk/upload/files/152/certificate-lomanco.pdf>

Product and Certification Body: Hudcova 424/56b, 621 00 Brno, Czech Republic

Construction Technical Certificate: 202-STO-B-02927-19 of 17-10-2019

Certification scheme applied: ČSN EN ISO/IEC 17067 2014, Scheme 1a

Company ID No. 60728159

Certificate No. B-03005-19

Products: Ventilation turbines

Versions: BIB (BEB) 12, BIB (BEB) 14, TIB (TEB) 12, TIB (TEB) 14, IB 8, BIB 8

Manufacturer: Lomanco Inc. 2101 West Main Street, Jacksonville, Arkansas 72076 USA

Valid from: 29-11-2019 **Valid to:** 30-11-2022

About Alu Roofing



- We also started the CPDPN process to gain RIBA accreditation.
- Our UK Sales Director Phil Brown (fully trained and certified at Lomanco CZ) deals with the enquiries in the UK . Looking after our customers and partners for nearly 4 years now, Phil will answer any questions you may have with the backup of our Technical support from Lomanco CZ and USA.
- Based in Wiltshire, covering the UK he has good experience within the Metal Roofing and Roof Ventilation Industry and with further information can make suggestions for your issues or projects.

Why are we in the UK?

In Approved Document C, BS 5250 Code of practice for control of condensation in buildings refers to 'avoiding problems with high moisture levels and condensation in buildings'. As this was only amended in 2016 this would suggest there are lots of substandard roofs that could be retrofitted with a suitable solution.

More people are after greener ways to construct and run their homes ventilation

Moisture is known to cause lasting damage which can be costly to repair.

Proper ventilation will reduce condensation issues, as well as extracting unwanted heat build up

Why should you ventilate void spaces?

We refer to Provisions in Approved Document F as the turbine can be used for Extract, Whole Building and also Purge with our Electrically controlled options

- **HEAT BUILD UP**-Unventilated void spaces in summer can suffer with heat build up and consequently hold onto stuffy hot air throughout the home or place of work. (Regulation flaps are available to control extraction when it is not needed)
- **CONDENSATION**-Unventilated void spaces in cold spells can also cause long term damage with a build up of condensation.

Wind powered ventilation will reduce any of the above issues and has a life long warranty for residential homes, meaning a green, one off cost with little maintenance

Two main areas of application for turbines

➤ Ventilation of roof void spaces

- Overheating of the attic space also overheats the interiors, which worsens living in such an interior and can lead to temperature in the living area.
- If the roof structure is insufficiently ventilated against the formation of moisture, the use of turbines is a suitable means of getting rid of the moisture without building interventions
- In structures where air conditioning is used, the heat load is reduced, the temperature drops and the air conditioning costs could also reduce.

➤ Ventilation of interiors

- The turbines can also be used as a replacement of the central electric fan connected to ventilation shafts - i.e. they ventilate individual apartments, their bathrooms and common areas
- The turbines are also used to ventilate production areas where heat is generated during production and is held at the ceiling of the building, including mezzanine areas

NB. Fire controls must be considered when installing the turbines-regulation flaps (referring to Approved Doc B). The flaps control airflow and are also available on the market.

What happens under your roof spaces during the year?

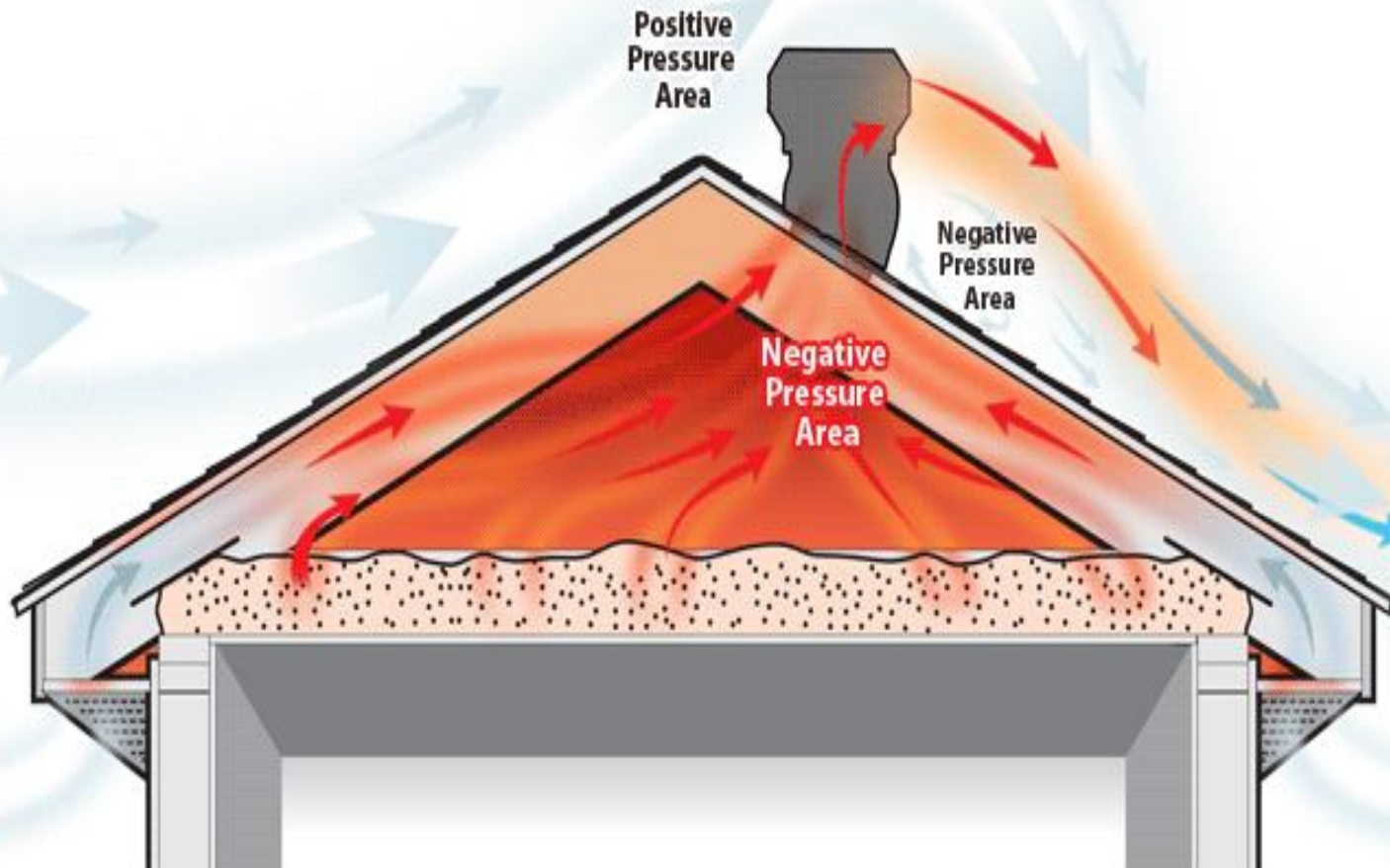

Why should you ventilate your roof?

Here are some images of damage caused due to poor roof ventilation..



**this damage
could have
been
avoided with
the right
type of
ventilation in
place**

Why should you ventilate your roof?

metal roofing especially suffers from condensation



How to ensure proper ventilation

Types of loft ventilation

Passive Vent



Active Vent



Benefits of using Wind Powered Ventilation

- **Extends the life of the roof structure** – the turbines exhaust damaging heat and moisture from attic space
- **Savings on operating costs** – Zero operating costs for ventilation of apartments
- **Green product** - no electricity is needed for operation, and the product is 100% recyclable
- **No maintenance** - all-aluminium rust-free construction, permanently lubricated upper and lower Teflon ball bearings
- **21 air-foil curved vanes with rolled edges** - deflects water from dripping in through the turbine head -test certificate here http://media.lomancovents.com/ALL_ACCESS/lmc_specs-online/beb-14.pdf
- **Resistance** - tested to withstand winds of 110 mph (149 mph – reinforced model) also covered in the above certification.
- **Easy installation** - vari-pitch base adjusts to 0° - 45° roof pitch
- **Long-term warranty** - Lifetime warranty for residential use, 15 year warranty for commercial

*Ref. Independent Wind Tunnel Testing Ryan Engineering (Arkansas) + TEES (Texas Engineering Experiment Station)



Technical Information

Type	BIB (BEB) 12	BIB (BEB) 14	TEB (TIB) 12	TEB (TIB) 14	IB 8
Head and ring material	Aluminium	Aluminium	Aluminium	Aluminium	Aluminium
Suction port diameter (mm)	305	356	305	356	203
Head Diameter (mm)	440	460	440	460	320
Weight (kg)	2.7	3	1.8	2	1.9
Max wind speed (km/hr)	120				
Ambient temperature	from -30 ° C to + 60 ° C				

Type/ wind speed	8km/hr	13km/hr	24km/hr
BIB (BEB) 12	590	930	1750
BIB (BEB) 14	710	1200	2250
TEB (TIB) 12	590	930	1750
TEB (TIB) 14	710	1200	2250
IB 8	165	295	565

The Construction

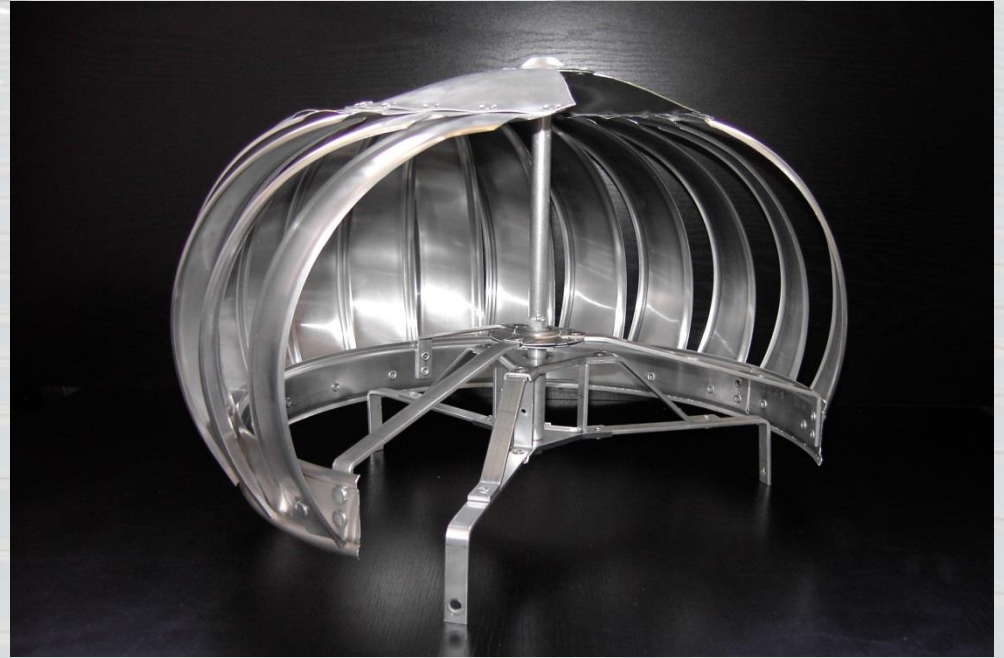

All Aluminium construction, including reinforcement elements

Energo hybrid sets

Hybrid turbines – automatic ventilation

This ventilation system no longer depends on a single source, wind power, it can also be driven by electricity. The turbine is supplemented by an intelligent control unit and an additional electric ventilator with a gearbox that can assist turbine rotation during adverse weather conditions. In the absence of wind energy to rotate the turbine, the system's control unit will switch to electricity as a power source.

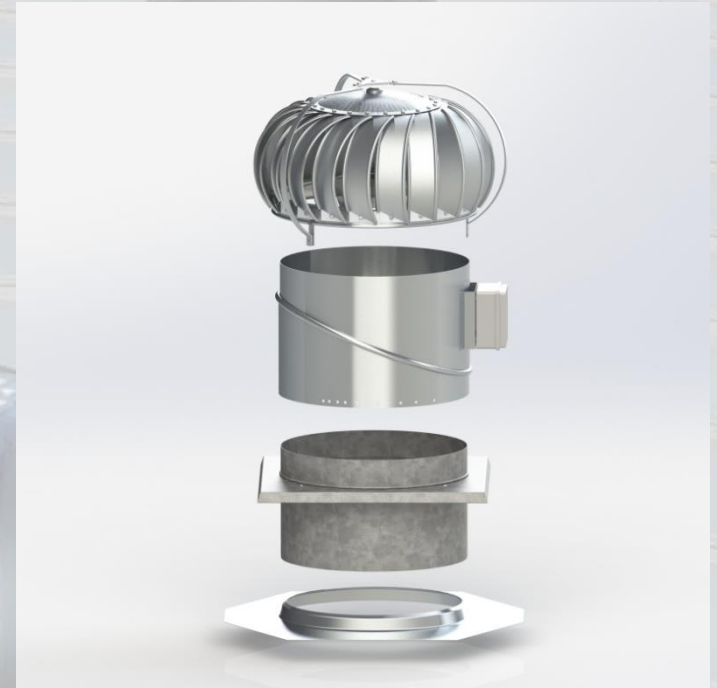

Energo hybrid sets

- Guarantees constant performance
- Intelligent control unit
- Can be used with regulation flap to open or close airflow manually or switched.
- Revolution sensor
- Optional sensor connectivity
 - thermostat
 - humidity sensor
 - CO2, PIR sensor or timer

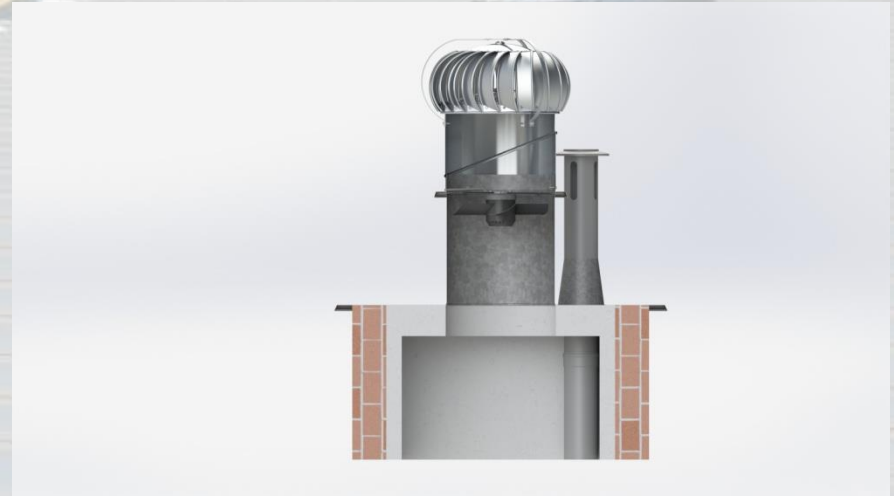

Sets

Sets with auxiliary electric ventilator

Hybrid ventilators are used to guarantee or increase the turbine's immediate output during adverse weather conditions or poor current performance.

- ✓ Popular solution for apartment houses
- ✓ A great substitution for central electric ventilators
- ✓ Reduces energy bills
- ✓ Guarantees constant performance



EVL 1400: 900-1400m³/h, 35Pa, 35W, 58dB – very quiet operation

EVL 3410: 2400– 3410m³/h, 170Pa, 230W, 73dB –powerful vacuum fan

Other applications of Ventilation Turbines

- **Ventilation of Factories**-reduces the temperature in the workplace when needed.
- **Ventilation of Warehouses**-exhausts moisture in winter, and overheated air in the Summer
- **Ventilation of agricultural buildings**-Fresh air and good ventilation is known to benefit the health of Livestock <https://dairy.ahdb.org.uk/technical-information/animal-health-welfare/mastitis/working-arena-prevention-of-infection/housing/ventilation-in-livestock-buildings/#.Xk1gE4jgpdg>

Agricultural and Industrial Buildings realisation examples

Busy cold store



Clothing warehouse



Horse training sand school



Industrial storage



Cow sheds



Farming unit



Blocks of flats

12 Storey block of flats



10 Storey hotel block







7 Storey housing block



Residential houses



How many turbines do I need?

Dimensions (in)					Calculating ventilation			Number of turbines needed				
model	hole size	height	base (shape)	weight (packaged)	wind speed			ventilated area*				
					8 km/h	13 km/h	24 km/h	0-90 m ²	>90 m ²	>140 m ²	>185 m ²	>230 m ²
BIB 12	12	17,25	20 x 20 	6,5 lbs	590 m ³ /h	930 m ³ /h	1750 m ³ /h	2	2	3	4	4
BIB 14	14	20	22 x 22 	7,5 lbs	710 m ³ /h	1200 m ³ /h	2250 m ³ /h	2	2	2	3	3
BEB 14	14	20,375	22 x 22 	7,75 lbs	710 m ³ /h	1200 m ³ /h	2250 m ³ /h	2	2	2	3	3
TIB 12	-	11,25	-	4,5 lbs	590 m ³ /h	930 m ³ /h	1750 m ³ /h	2	2	3	4	4
TIB 14	-	11,625	-	4,75 lbs	710 m ³ /h	1200 m ³ /h	2250 m ³ /h	2	2	2	3	3
GT 12	12	15,75	20 x 20 	9 lbs	590 m ³ /h	930 m ³ /h	1750 m ³ /h	2	2	3	4	4
IB 8	8	14,25	-	4 lbs	165 m ³ /h	295 m ³ /h	565 m ³ /h	3	6	9	12	12
VP 8	8	7,75	16 x 16 	2,25 lbs	-	-	-	-	-	-	-	-

* The information is for reference only. The exact number of units needed always depends on the roof shape and overall dimensions of the roof.

Installation

MUST DO STEPS

- Installation can be carried out by any roofing or construction expert-all installation instructions are included.
- Install all Exhaust Ventilation at the SAME HEIGHT within a common void space area.
- Install only one type of Exhaust Ventilation within a common loft area.
- Install a 50/50 balanced system of Intake and Exhaust Ventilation.
- Use appropriate flashings for the roofing type
- **Not suitable for chimney/log fire smoke extraction**

Main principles of installing turbines

General installation rules:

- Turbine head in upwind position
- Turbine head above roof ridge, above attic
- Turbine head always leveled horizontally
- Sufficient size of fresh air intakes

Ventilation of roof construction:*

- Use one 14" turbine for each 50 - 80 m² of flat
- Ideal spacing between turbines is 3 – 7 metres
- Size of fresh air intake minimum 1:1 of turbine flat

Ventilation shafts within tower blocks:*

- Tower blocks up to 5 floors - use min. One 14" turbine per shaft
- Tower blocks of 7+ floors – two 14" turbines per shaft

*for guidance only, correct information can be provided if we are told the values needed

Installation



• Incorrect



• Incorrect

- Ensure the turbine head is dead level whilst installing
- Fasten the turbine with 3 provided screws
- Do not use self-tapping screws



• correct

Incorrect installation example



Too close together and ineffective

Health and Safety

✓ Installation

Installation must be carried out by a professionally trained company with authorisation for working at heights – there are various CPD approved WAH training courses available

✓ Control of turbine operation

The operation of the turbine must be visually checked at least once a year

During the inspection we will focus on whether the turbine rotates regularly and without stalling

Operation must be free of any humming and rubbing

The product must be manually checked on every few years, to ensure there is no clogging - check that the blades are not loose and the turbine head is dead level

✓ Maintenance

The bearing system is maintenance-free

The construction of turbine is 100% made of aluminium and it is rust-free

If the blades or turbine head is deformed, it must be replaced



For further information



www.aluroofing.co.uk

Phil Brown

Sales Director

07747 797955

phil.brown@aluroofing.co.uk

Video turbine smoke house demo:

<https://www.youtube.com/watch?v=8wDZ3WKGqlo>

Installation Video:

<https://www.youtube.com/watch?v=oq8l4sWlim4>

